

Vanitex

Installation Guide. Care and Maintenance. Warranty.

A PIECE
OF LUXURY



YOUR HANDY
GO-TO GUIDE

[VANITEX.COM.AU](https://www.vanitex.com.au)

Installation Guide. Care and Maintenance. Warranty.

Please inspect all Vanitex products within 48 hours of receiving your goods to ensure there are no damages or incorrect items received. No claims for damages or incorrect items will be recognised after this period or after installation has taken place.

If the packaging of your product has been damaged, please photograph the damages immediately prior to unboxing. Continue unboxing and inspect for any damages to the product itself. Photograph all damages that have incurred and contact Customer Service at hello@vanitex.com.au

(Please note: Wall fixings are not supplied for installation).

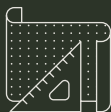

All Vanitex products **MUST** be installed by a qualified tradesperson and finished with a high-quality standard. Warranty is voided against faulty/poor workmanship and unqualified installation.

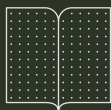

Ensure this Installation Guide has been issued to the assigned qualified installer and it has been read thoroughly prior to installation.

- 02. Read Me
- 04. Checklist
- 06. Vanity Installation
- 10. Mirrored Cabinet Installation
- 14. Fillers
- 16. Drawer Adjustments
- 18. Hinge Adjustments
- 20. Care and Maintenance
- 22. Warranty

Quality.
Flexibility.
Trustworthy.
Trendy.

Before you install checklist.

Please contact Customer Service at hello@vanitex.com.au if you need additional support with your installation or require further information on care and maintenance and warranty.

1. Wall supports

Ensure the wall where the product will be installed has suitable fixing supports located behind the product.

Tip: For timber stud walls, we recommend setting out studs to be positioned to the overall length of the vanity, with additional studs for larger models. Noggins affixed between studs within the upper and lower location of the product at a minimum.

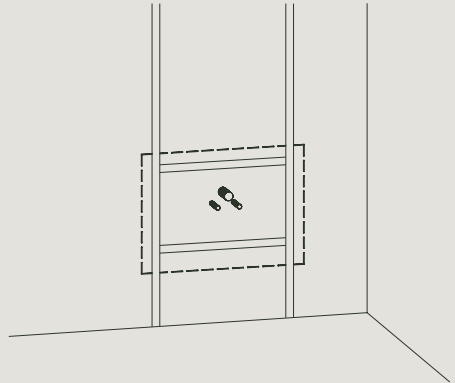

2. Check for plumb and straight walls

Ensure the wall is plumb and straight, so the product is fixed back to the wall and retains its correct shape.

Tip: Fixing to bowed walls can cause the product to twist and distort, which can lead to door/drawer adjustments being very difficult to correct. If existing walls aren't plumb and straight, ensure correct packing behind the product is placed where required.

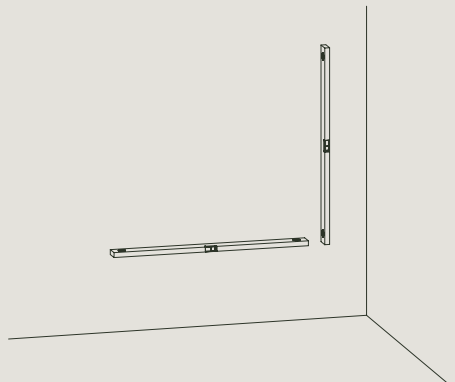

3. Service positioning

Ensure services have been installed in the correct location to suit the product configuration.

Tip: This includes wall mixers to be installed at the correct height in reference to your basin set-out height.

(Please refer to the specific Product Specification document to find these locations).

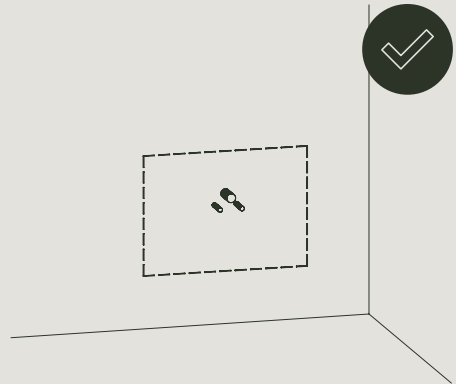

4. Make note of service locations

Ensure you make note of service locations that are located within the wall where the product is being affixed, to avoid fixing into them. This can lead into water leaking pipes and damaged electrical cables.

Tip: Taking photos of internal walls with a tape measure held across the wall, prior to them being concealed, is a great way of referring to service locations.

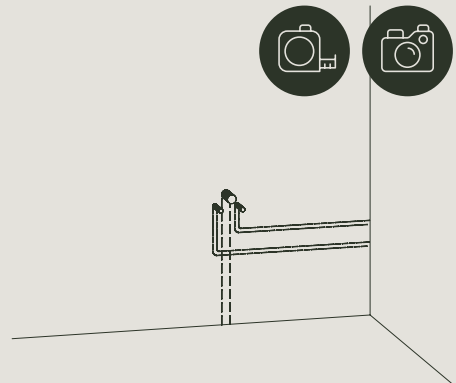

5. Positioning within your bathroom space

Ensure the product is positioned in a location where no direct spray or splash of water will come in contact. Sufficient ventilation should be apparent within the room, to ensure excessive moisture doesn't occur. This can lead to permanent damage of materials and is not warranted. Products are constructed from moisture resistant materials, though they are not waterproof.

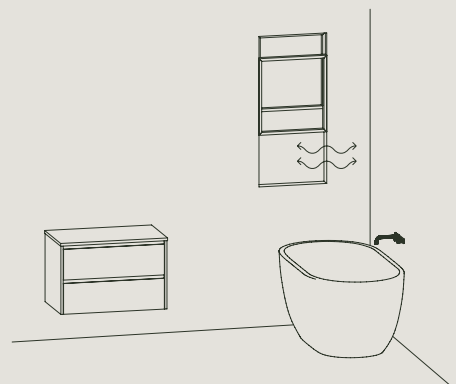

Vanity installation.

Please contact Customer Service at hello@vanitex.com.au if you need additional support with your installation or require further information on care and maintenance and warranty.

1. Preparation

- Set-out the height position of your vanity on the wall by marking a line for the top of the cabinet (wall mount only).

Tip: Factor in benchtop thicknesses and basin heights when setting out, to ensure the overall height is achieved correctly.

- Remove drawers and doors.
- Conceal drawer runners with masking tape (or alike) to ensure debris cannot fall within them as this can damage the hardware components and void warranty.
- Using the correctly sized hole saw, measure and cut-out service locations within the back and/or bottom of the cabinet.

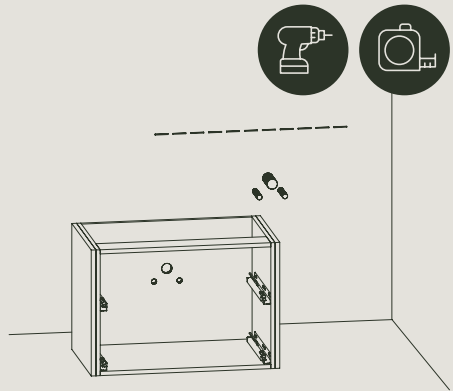

2a. Levelling (wall hung)

- Position the vanity on the wall and support from underneath. Pack the underside of the vanity to ensure it is level and aligns with the set-out line drawn in Step 1. Check level by using a spirit or laser level.

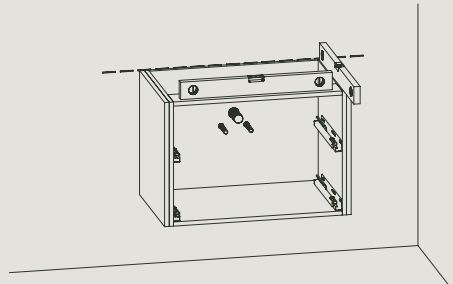

2b. Levelling (floor standing)

- Affix legs to the underside of the vanity using the supplied fixing screws.
- Position the vanity on the floor and against the wall. Whilst taking weight off the legs, thread the adjustable fitting on the bottom of the legs, to achieve the correct height required. Check level by using a spirit or laser level.
- **Note:** Legs can be adjusted +10mm.

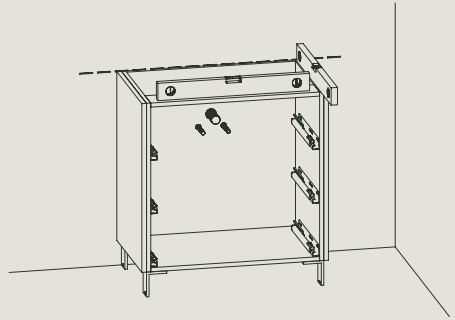

3. Fixing cabinet

- Use the correct wall fixings required as per the applicable wall construction.
- Ensure a sufficient amount of fixings have been made in accordance with the overall size of the vanity.

Tip: Use mud washers with screw fixings to increase the surface area of fixing and eliminate the chance of fixings popping through the back material.

- Ensure fixings have been made both top and bottom corners of the vanity at a minimum, though further central fixings are required on larger models.

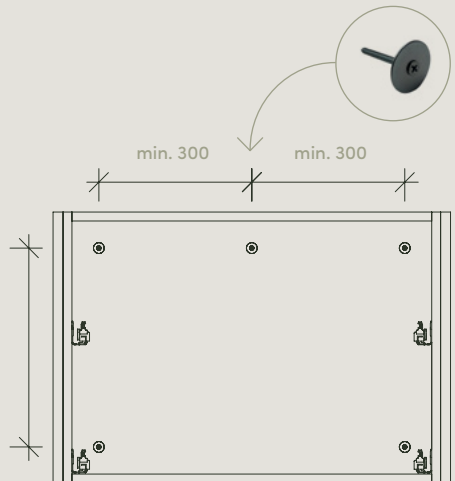

4. Fixing benchtop/basin

- Adhere the benchtop to the top of the cabinet by using a non-acetic cure silicone and placing a continuous bead around the perimeter of the top of the cabinet.
- Position the benchtop so it has equal overhang on both sides.
- Place a few dabs of silicone on the benchtop where the basin is to be positioned and sit the basin in its final position.

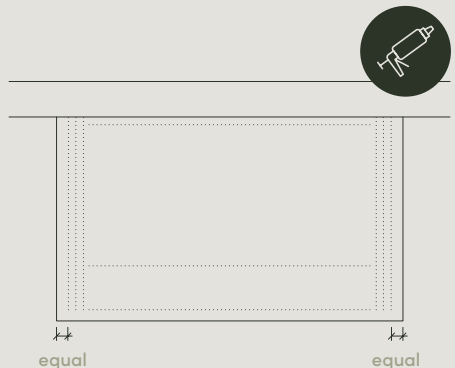

5. Cleaning

- Vacuum and wipe all debris and dry any spillage or leakage of water on or inside the cabinet. For vanity care and maintenance, see page 20–21.
- **Note:** Clean external finishes of the vanity after all adjustments have been made.

Tip: Ensure any debris that may have got within the concealment of the drawer runners are vacuumed out before re-installing drawers.

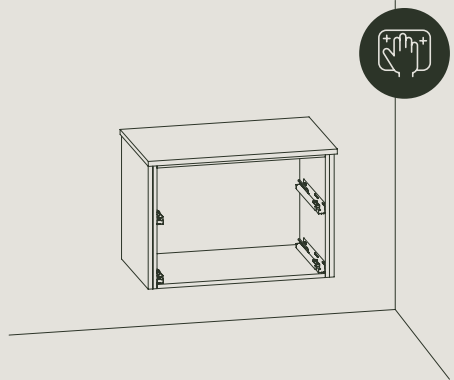

6. Adjustments

- Re-install drawers and/or doors back onto the cabinet and adjust accordingly. See pages 16–19 for instructions.
- **Note:** If applicable, install handles onto fronts by using the supplied fixing screws. Ensure this is done by using a screwdriver by hand and not a power drill, as this can strip the handles thread if excessively performed.

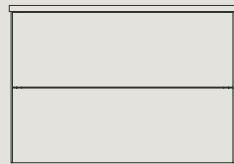
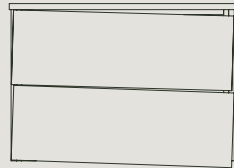

7. Sealing

- Apply a bead of non-acetic cure silicone to all edges where the vanity top and cabinet meets the wall.
- Also apply a bead of silicone around the perimeter of the basin and benchtop junction (where applicable).

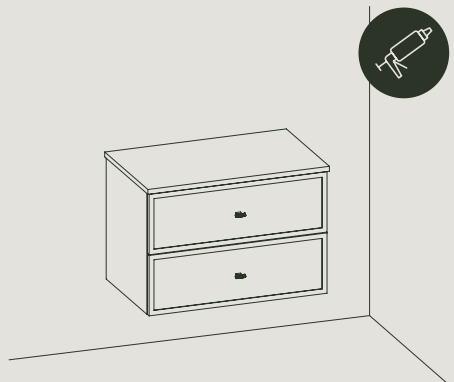



Share your
installed vanity
with us!

@vanitex.australia

Mirrored cabinet installation.

Please contact Customer Service at hello@vanitex.com.au if you need additional support with your installation or require further information on care and maintenance and warranty.

1. Preparation

- Place the cabinet on a flat surface facing upwards to remove the mirrored doors and shelving. Ensure the doors are placed on a flat surface with the mirrors facing up to avoid any damages.
- Using the correctly sized hole saw, measure and cut-out service locations within the back of the cabinet (if applicable).
- Set-out the height of the cabinet and draw a level line noting the bottom of the cabinet.

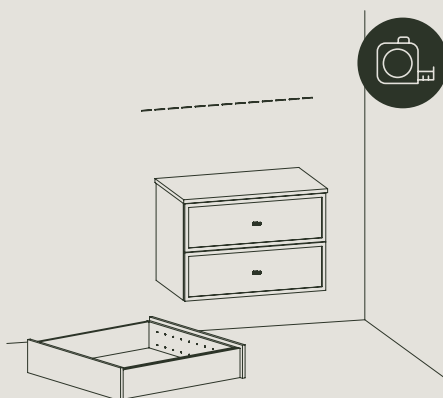

2. Levelling

- Position the cabinet on the wall and support from underneath. Pack the underside of the cabinet to ensure it is level and aligns with the set-out line drawn in Step 1. Check level by using a spirit or laser level.

Tip: Using threaded cabinet stands allows mirrored cabinets to sit on top of them and the vanity, to allow accurate height adjustment and free up hands.

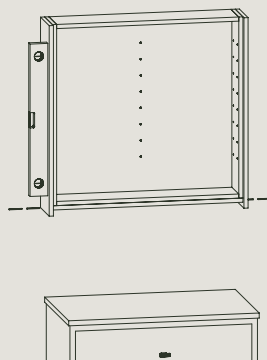

3. Fixing cabinet

- Use the correct wall fixings required as per the applicable wall construction.
- Ensure a sufficient amount of fixings have been made in accordance to the overall size of the cabinet.
- Ensure fixings have been made both top and bottom corners of the cabinet at a minimum, though further central fixings are required on larger models.

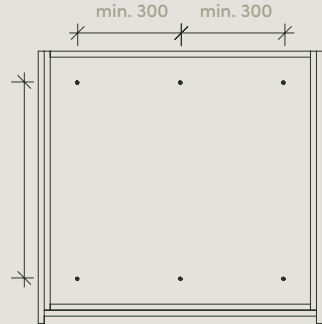

4. Cleaning

- Vacuum and wipe all debris from inside the cabinet.
- Clean external finishes of the mirrored cabinet after all adjustments have been made. For mirrored cabinet care and maintenance, see page 20-21.

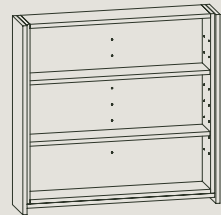

5. Adjustments

- Re-install mirrored doors back onto the cabinet and adjust accordingly. See pages 18-19 for instructions.
- **Note:** If required, it is the responsibility of the installer to make any adjustments to doors after installation.

Caution: Ensure mirrored doors are adjusted to allow sufficient door gaps in order for mirrors to not touch one another, as this will cause breakage of the mirror edge. Also allow sufficient gap when installing against adjacent walls.

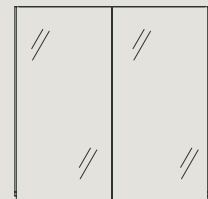
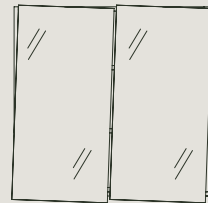

6. Sealing

- Apply non-acetic cure silicone to the entire perimeter of the cabinet where it meets the wall.



7. Optional – recessing mirrored cabinets

- If recessing your mirrored cabinet, please have a minimum of 2mm perimeter clearance around the niche to ensure the cabinet fits within.
- Ensure the cabinet carcass protrudes a minimum of 20mm from the niche to allow a sufficient finger pull distance to remain, allowing opening of doors.

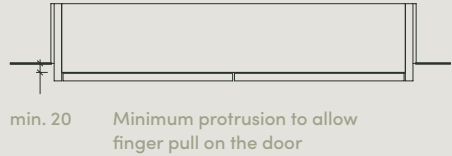

Share your
mirrored
cabinet with us!

@vanitex.australia



Fillers.

Please contact Customer Service at hello@vanitex.com.au if you need additional support with your installation or require further information on care and maintenance and warranty.

Introduction to fillers

Fillers (also known as in-fill panels) are typically used when installing a vanity or mirrored cabinet up against the wall or between walls. By installing fillers, it allows offset distance for drawers/doors from walls and opposing details such as door architraves, etc.

When fillers are ordered, the cabinet length is reduced by the thickness of the filler material, in order for the overall length ordered to be retained.

Filler thicknesses vary as per the external material selected, being;

- Solid Colour & Polyurethane Paints = 18mm
- Woodgrain Textures = 16mm

Method 1 (using filler on edge)

- The filler should be scribed (if required) to suit the distance remaining from the installed level cabinet and the wall.
- Affix the filler to the side required by screw fixing through the internal side of the cabinet.

Either a set-back or forefront detail can be achieved as pictured.

- **Note:** This method in a set-back format is the recommended method for mirrored cabinet fillers, as the supplied filler is the same height as the mirror cabinet door and the same depth as the cabinet side.

Set-back

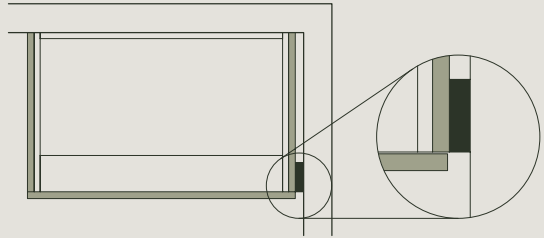

Forefront

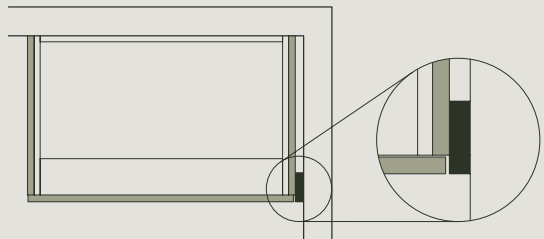

Method 2 (using face of filler)

- The filler should be scribed and cut to suit the distance remaining from the installed level cabinet drawer/door and the wall.
- Affix the filler to the side required by screw fixing through the internal side of the cabinet for when a set-back detail is to be achieved.
- To achieve a forefront fixing, screw fix the offcut flush to the cabinet side, allowing the scribed piece to be adhered onto its edge.

Tip: Ensure a drawer/door gap has been accommodated for forefront applications.

Set-back

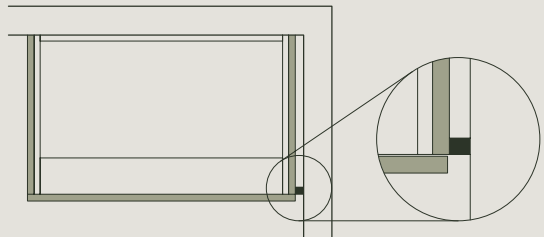

Forefront

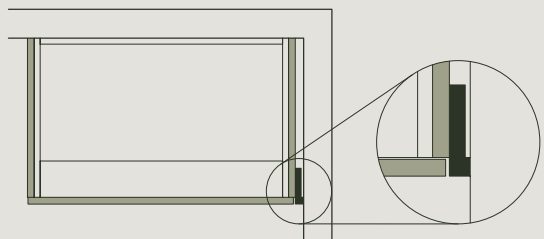

Drawer adjustments – Blum® Legrabox.

Removing drawer

Pinch the levers on either side of the underneath of the drawer and slide the drawer out simultaneously.

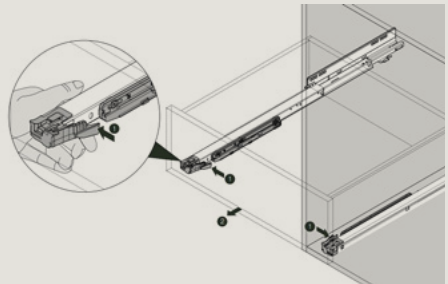

Inserting drawer

Place the drawer back on top of the runners and slide the drawer back into the cabinet until you hear the click of the runners engaging with the drawer clips underneath.

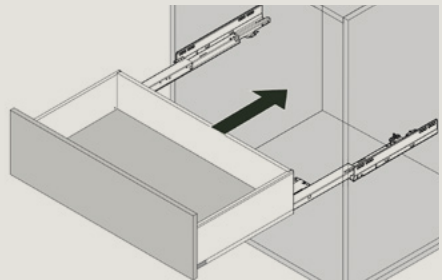

Height adjustment

Use the supplied T20 hex key to turn the screw as pictured to achieve up and down adjustment.

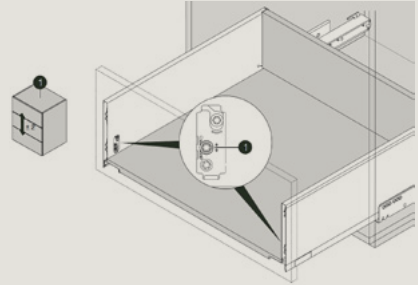

Side adjustment

Use the supplied T20 hex key to turn the screw as pictured to achieve left and right adjustment.

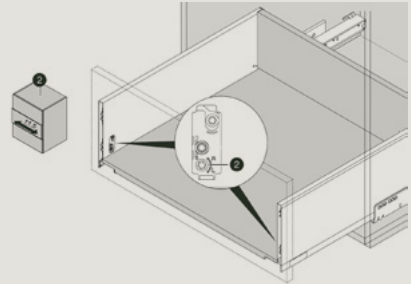

Tilt adjustment

Use the supplied T20 hex key to turn the screw as pictured to achieve tilt adjustment.

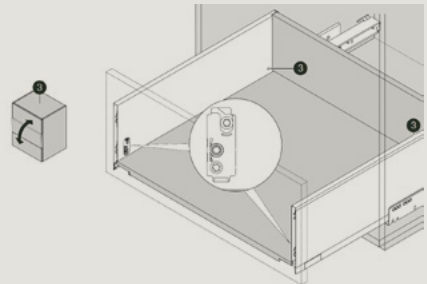

Depth adjustment (push-to-open only)

Turn the pictured plastic gear to make adjustment of the closed position of the drawer. Ensure no less than a minimum of 2.5mm to allow the push-to-open mechanism to engage and function.

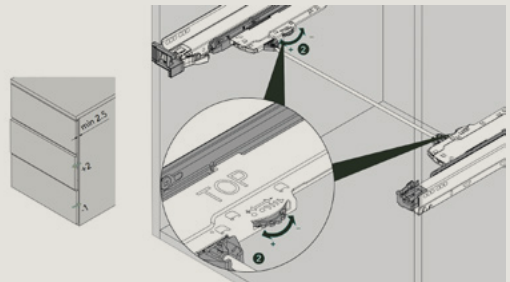

Hinge adjustments.

Removing hinge

Unclip the hinge off the mount from the back of the hinge.

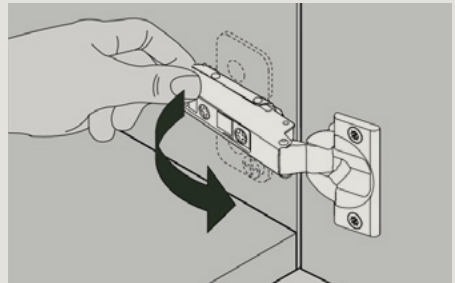

Inserting hinge

Place the hinge into the front of the mount and push on the back of the hinge to clip it on the mount.

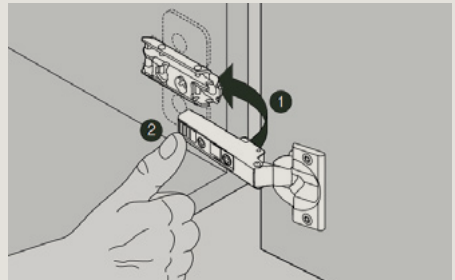

Side adjustment

Turn the pictured screw anti-clockwise and clockwise to adjust left and right accordingly.

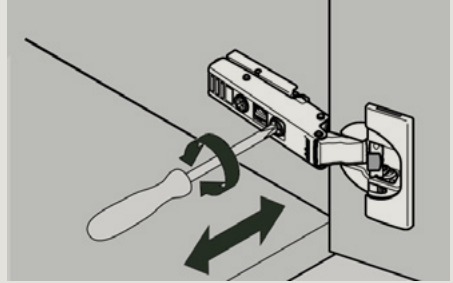

Depth adjustment

Turn the pictured screw anti-clockwise and clockwise to adjust the depth accordingly.

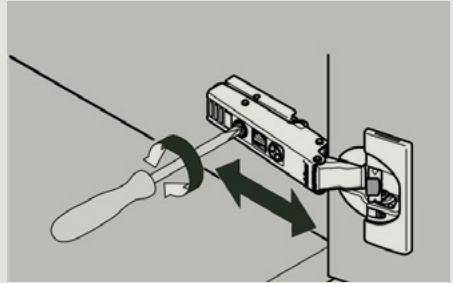

Height adjustment

Turn the pictured screw anti-clockwise and clockwise to adjust up and down accordingly.

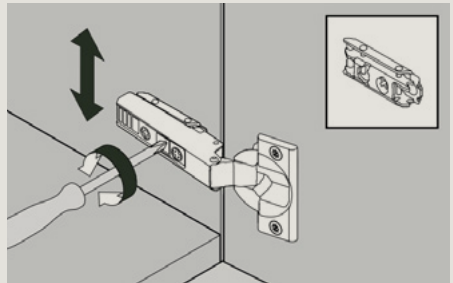

Care and maintenance.

Please contact Customer Service at hello@vanitex.com.au if you need additional support with your installation or require further information on care and maintenance and warranty.

Cabinets (excluding polyurethane paint)

- To keep your bathroom cabinetry looking clean, use a soft cloth and a weak solution of non-abrasive detergent to wipe down the cabinet inside and out, to then dry promptly with a dry cloth.
Tip: Do not rub excessively hard as some cloths can be abrasive and you may permanently damage the finish by buffing an area. We recommend the use of microfibre cloths.
 - Materials used are moisture resistant and not waterproof. Therefore, if pools of water occur, ensure this is mopped as soon as it occurs.
-

Polyurethane paint finish

- Use a slightly damp microfibre cloth and rub lightly, ensuring you follow with a dry microfibre cloth to remove damp residue.
-

Caesarstone®

- Caesarstone® requires very little maintenance however for an everyday clean we recommend wiping the surface with warm soapy water (a mild detergent) and a clean damp cloth.
 - Caesarstone® never requires polishing and avoid prolonged rubbing in one spot when cleaning to ensure no permanent buff marks occur.
-

Corian®

- Every day clean – As a general rule with any surface, start with a simple clean and avoid using abrasive scouring pads for routine cleaning.
- To remove grime, use soapy water or an ammonia based cleaner along with a damp sponge or cloth. Rinse well.
- Deep clean – For more stubborn stains, you will need to give your Corian® a more thorough clean using a mild abrasive product like Gumption, Jiff or Ajax cleaner along with a Scotch Brite non-scratch pad or damp cloth. Always finish by rinsing and wiping your surface with a damp cloth or sponge.

Ceramic products

- Ceramic is quite durable and easy to look after. For general use, squeeze a small amount of detergent onto the soft side of a sponge and clean by rubbing over the surface in a small, circular motion. Conclude with rubbing the surface dry with a microfibre cloth.

Stainless steel products

- Ensure you use natural cleaning products only and no abrasive cleaning cloths.
- Routine clean with warm soapy water and use a microfibre cloth.
- Dry after each use to reduce watermarking and surface rust.
- When cleaning, wipe in the direction of the brushed grain to maintain the brushed appearance.
- Ensure you do not let the water pool and remain.

Mirrors

- To leave your mirror with a smear-free finish, use a slightly damp microfibre cloth to remove dust and grime, followed by a dry microfibre cloth to remove any moisture smears.
- Do not use products such as glass cleaner on your mirrors as this can harm the glass by eroding the silver backing over time.

Warranty.

Product	Domestic	Commercial
Cabinetry (excluding mirror)	7 years	1 year
Caesarstone® benchtops	10 years	10 years
Corian® benchtops	10 years	10 years
Ceramic products	5 years	1 year
Stainless steel products	5 years	1 year
Mirrors	1 year	1 year
Blum® hardware	Lifetime*	Lifetime*
Handles	1 year	1 year
LED lighting	3 years	1 year
Pop-up wastes	1 year	1 year

(*) The warranty period is 20 years for Blum® hardware as this is considered lifetime of the furniture.

WARRANTY

Product ID number

(found underneath top drawers or front upper left side)

First name

Last name

Email

Product installed by

Trade licence number

Installers contact number

Company name

Purchase date

Installation date

Installation address

Our goods come with guarantees that cannot be excluded under the Australian Consumer Law.

You are entitled to a replacement or refund for a major failure and compensation for any other reasonably foreseeable loss or damage. You are entitled to have the goods repaired or replaced if the goods fail to be of acceptable quality and the failure does not amount to a major failure.

Vanitex will provide replacement products to the original purchaser when any instructions issued by Vanitex have been complied with, including without limitation, that the product has not been subject to; improper use, improper operation, installed by an unlicensed tradesperson, under excessive load, normal wear and tear, water and/or excessive moisture damage, chemical damage, heat damage, cleaning products used that were not specified in the Care and Maintenance guides.

Vanitex will be responsible for any expenses associated with sending the replacement parts to your address (within Australia). Removal of the defective product and/or installation of the replacement part is not covered under this warranty.

Warranty will be voided if damage occurred during or after installation, or a damaged or incorrect product has been installed prior to notifying Vanitex.

In the event of a claim, quote your product ID number (found underneath top drawers or front upper left side) and contact Vanitex Customer Service by email, hello@vanitex.com.au, where our customer service team will advise you on the process.

Vanitex

@VANITEX.AUSTRALIA
HELLO@VANITEX.COM.AU
VANITEX.COM.AU